

ROCKETAIL



Installation Manual

Hinge #2

Rocketail - #1 in ROI for Rear Drag Reduction

Installation Manual - Hinge #2

THIS DOCUMENT OUTLINES THE INSTALLATION PROCEDURE FOR THE ROCKETAIL AERODYNAMIC SYSTEM.



Rocketail install will take two people with experience about 35 minutes for a dry van and 1 hour and 15 minutes for a reefer. All installations should be performed by an experienced mechanic.

1 Mark trailer frame for Base Plate install

Trailer doors closed

- Measure from roof line and mark rear trailer post at 23" and 72." Repeat on both sides of trailer.
- Use speed square to mark the width of the trailer frame post.

Note: Measure from forward of the rear header.

Tools & Materials: tape measure, speed square, sharpie



2 Attach Base Plates

Trailer doors opened to 90 degrees

- Center Base Plate on mark from step one and align back of Base Plate with back of trailer frame.
- Use Base Plate as guide to mark holes.
- Only mark top hole and center hole for now.
- Using F drill bit, drill top and center holes.
- Insert and pop the 1/4" stainless steel structural rivet in top and center holes.

X4

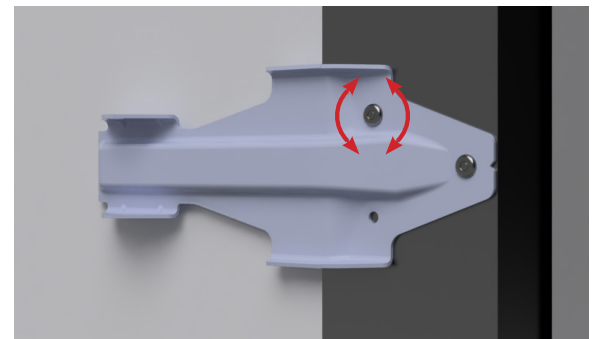

Note: center hole has additional tolerance to allow micro adjustments prior to fixing position with final rivet.

- Ensure Base Plate is square using speed square.
- Measurement from top of Base Plate to the top of the second Base Plate should be **49" ± 1/8"**.
- Once the position is correct, drill the bottom holes and pop the remainder of the rivets.

Only use the provided 1/4" stainless steel structural rivets. Watch for wires in the post.

Tools & Materials: (4) Base Plates, drill, F drill bit, sharpie, (12) 1/4" stainless steel structural rivets, 1/4" rivet tool

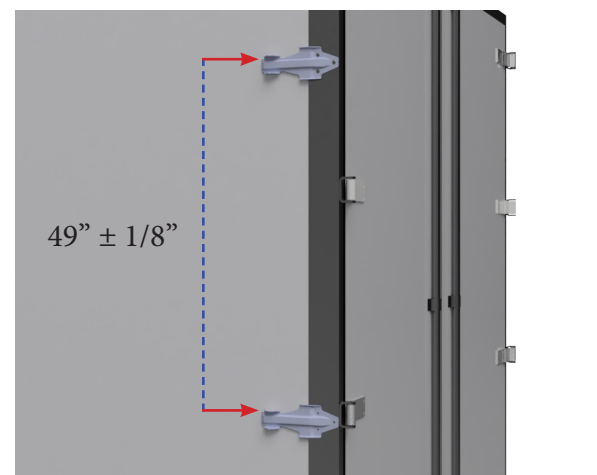

3 Attach Door Bracket

Trailer doors closed

- Measure and mark trailer door at 16.5" from side of trailer.
- Ensure mark is level with center of Base Plate.
- Drill hole using a 7/16" drill bit.

Note: Park trailer on level surface.

Tools & Materials: tape measure, sharpie, drill, 7/16" drill bit

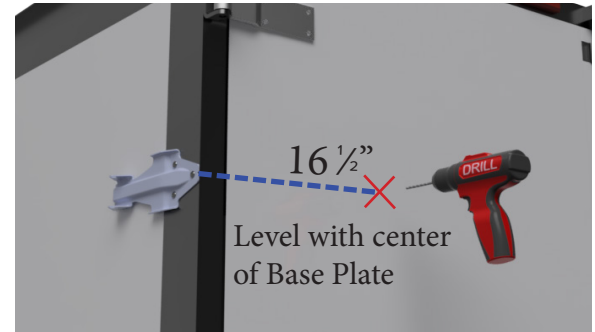

X4 Trailer doors opened to 90 degrees

- Dry Van - attach Door Bracket using provided 1.5" carriage bolts, 4" washer and 5/16" - 18 lock nut.
- Reefer - attach Door Bracket using provided 4.5" carriage bolts, 4" washer and 5/16" - 18 lock nut.
- Tighten lock nuts with 1/2" wrench.

Note: For reefers, inject silicone into drill hole before inserting carriage bot.

Tools & Materials: (4) Door Brackets, (4) 1.5" carriage bolt [4.5" for reefers], (4) 4" washer, (4) 5/16"-18 lock nut, 1/2" wrench

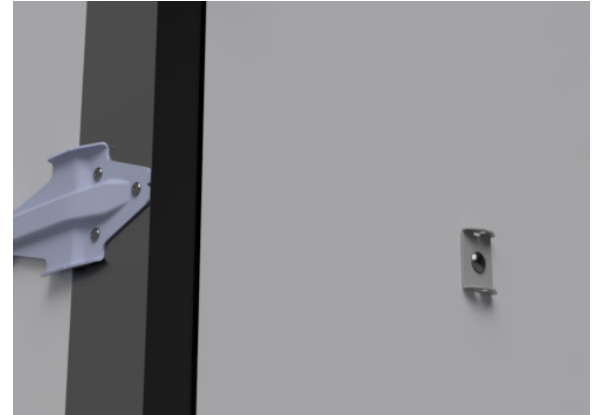

4 Hang Wings on Base Plates and Door Brackets

Trailer doors opened to 90 degrees

- Hang the Rocketail Wing on the Base Plate using provided 5/16" clevis pin and (2) 5/16" bushings.
- Attach Cable Bracket to Door Bracket using provided (2) 1/4" clevis pin.
- Add provided circle cotter to each clevis pin to secure.

Tools & Materials: (2) Rocketail Wing, (4) 5/16" clevis pin, (4) 1/4" clevis pin, (8) 5/16" bushing, (8) circle cotter

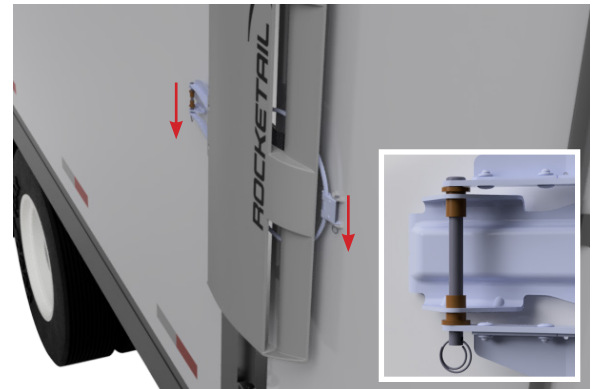

5 Mount Top Element

- Ensure Mounting Plate can slide with firm pressure.
- Align Top Element with back of trailer frame and center on trailer - do not extend over the back of the trailer frame.
- Slide Mounting Plates so that they are aligned with edge of trailer flange.
- Use Mounting Plates as guide to drill holes through flange using an F drill bit.
- Attach Mounting Plates to trailer flange using provided hardware - 3 bolts per side, evenly distributed.

 *Ensure trailer ride height does not exceed 13'6" with Top Element. Inspect roof for damage and repair if necessary. Leading edge should sit flush against trailer roof.*

Tools & Materials: 7/16 and 3/8 wrench, (6) 1" 1/4-20 flanged hex screw, (6) 1/4-20 flanged lock nut

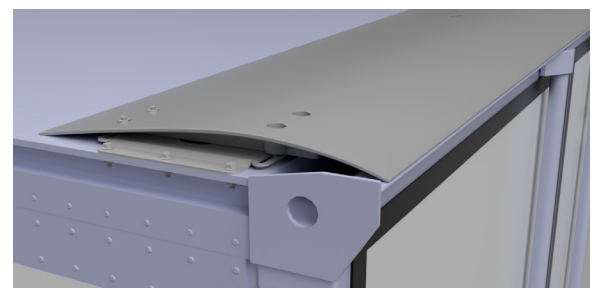
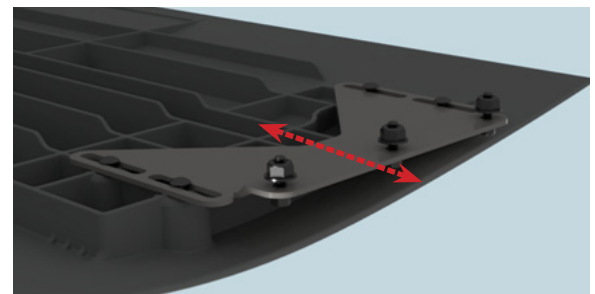



Required Tools





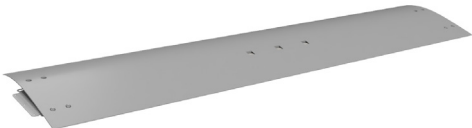





Tape Measure - Speed Square - Sharpie - Drill - 1/4" Rivet Tool - Ladder
Wrenches: 3/8", 7/16" & 1/2" - Drill Bits: F & 7/16" - [Silicone for Reefer]

Note: due to the nature of the product, all hardware is stainless steel. Therefore, hardware galling is possible and we recommend tightening hardware by hand to reduce the likelihood.

Rocketail Parts List

QUANTITY	PART NAME	PART NUMBER	DESCRIPTION	IMAGE
2	Wing	SB00101-02.02	Rocketail Wing Assembly	
1	Top Element	SB00201-01	Top Element w/ (2) Mounting Plates	
4	Base Plate	CP00602-01.17	Base Plate, mounts to trailer frame	
4	Door Bracket	CP00402-01.04	Door Bracket, mounts to trailer door	

Hardware List

QUANTITY	PART NUMBER	DESCRIPTION	IMAGE
12	HW00027-00	1/4" stainless steel structural rivet	
4	HW00018-00	3.5" 5/16 clevis pin	
4	HW00019-00	3" 1/4 clevis pin	
8	HW00003-00	circle cotter	
8	HW00017-00	5/16" copper bushing	
4	CP02201-01	4" OD flat washer	
4	HW00011-00	1.5" 5/16-18 carriage bolt [Dry Van]	
4		4.5" 5/16-18 carriage bolt [Reefer]	
4	HW00013-00	5/16-18 hex nut, nylon lock	
6	HW00012-00	1" 1/4-20 flanged serrated hex screw	
6	HW00014-00	1/4-20 hex nut, nonmarring flanged	